

This heater is approved for outdoor use only.



SUPAGAS
YES WE CAN!

Heatstrip

Safety warnings and operating instructions (please read all instructions carefully).

Safety Warnings - (use only with LP Gas)

- This appliance must NOT be used indoors. **OUTDOOR USE ONLY**
- Installation must comply with local authority requirements.
- Minimum clearances MUST be maintained from combustible materials: **500mm (top), 300mm (rear)** and **1000mm (front and sides)** e.g. Overhead structures, walls, furniture, fixtures and plants.
- This appliance must NOT be used in a building, garage or any other enclosed area.
- This appliance must only be used in a well ventilated area.
- This appliance must be placed on firm level ground.
- Do not install in very windy locations.
- Improper installation, adjustment, or alteration can cause personal injury and property damage.
- Do not transport or move appliance while it is operating.
- Do not expose the burners to water or moisture – heater must be protected from rain.
- If the appliance fails to operate correctly, contact place of hire or their authorised agent for advice and service. **DO NOT ATTEMPT REPAIRS YOURSELF**
- Do not place articles on or against this appliance.
- Do not store chemicals or flammable materials in the vicinity of this appliance.
- Do not spray aerosols or flammable materials in vicinity of appliance while it is operating.
- This appliance is NOT intended to be installed on recreational vehicles and/or boats and is NOT suitable for a marine environment.



Heater units direct their heat via infra-red rays which discharge the heat energy upon striking a surface. They do not pass through solid materials. When installing the unit, obstructions to the path of the rays must be considered from both a heating and safety point of view.

For the most efficient heating and safest working conditions, obstructions in the path of the heat rays should be avoided where possible. Ceiling clearance is also an important factor. Materials stored near the heater must be at a safe distance as the infra-red rays heat solid objects quickly.

Operating Instructions:

Turning the appliance on:

1. Before lighting, ensure the heater is situated on a firm level surface.
2. Remove the rear panel of the lower enclosure.
3. Check the connection which screws into the LP Gas cylinder. Make sure the rubber seal is in position (end of the regulator) and not cracked or damaged in any way.
4. Screw regulator assembly to gas cylinder and make sure connection is tight. This is a lefthand thread and turns counter clockwise to tighten.
5. Place gas bottle into lower enclosure and fasten strap tightly.
6. Turn heater control knob to **OFF** position.
7. Turn LP Gas cylinder valve counter clockwise to the **OPEN** position.
8. Check for leaks by applying soapy water (using non-ammonia based detergent) with spray bottle or soft cloth to LP Gas connections. A gas leak is indicated when bubbles appear in the soapy water.
9. Push and turn control knob to ignition position (↗) - a 'click' will be heard. This will trigger a spark to ignite the pilot burner. 3 or 4 attempts may be required. Once pilot flame is established, keep pressing control knob for a further 10 seconds to ensure burners remains lit.
10. When appliance is correctly turned on the tiles will start to glow red.
11. Replace the rear panel of the lower enclosure.

Turning the appliance off:

1. Turn LP Gas cylinder valve clockwise to the **CLOSE** position - this will burn off any gas left in the line.
2. Push and turn the control knob to **OFF** position

WARNING

After turning heater off, you must wait a minimum 5 minutes to let excess gas dissipate before lighting again.

FREE DELIVERY
*CONDITIONS APPLY

13 SUPA
13 78 72
supagas.com.au

This heater is approved for outdoor use only.



SUPAGAS
YES WE CAN!

Heatstrip

Note: The definition of outdoors is an above ground open-air situation with natural ventilation, without stagnant areas, where gas leakage and products of combustion are rapidly dispersed by wind and natural convection.

Please observe these diagrammatic representations of areas that are considered outdoors.

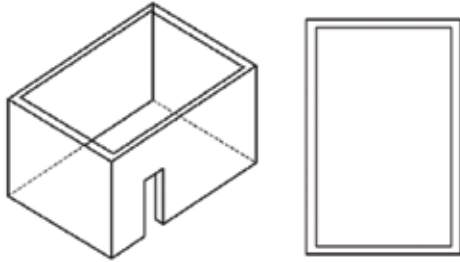

Outdoor Area - Example 1

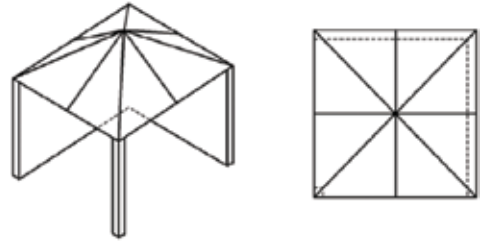

Outdoor Area - Example 2

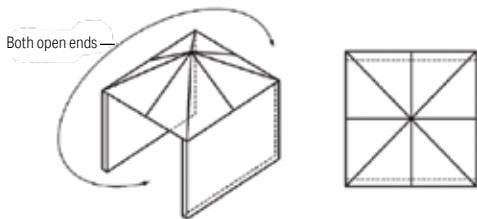

Outdoor Area - Example 3

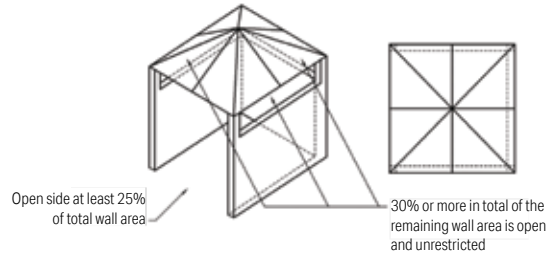

Outdoor Area - Example 4

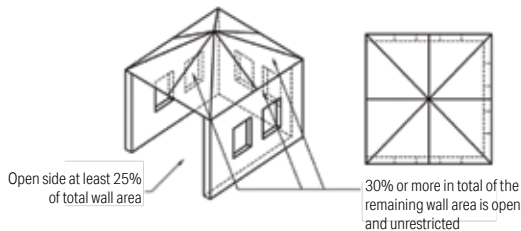

Outdoor Area - Example 5

WARNING
Improper installation, adjustment, or alteration can cause personal injury and property damage.

Please observe the following guidelines to minimum clearances required from combustibles

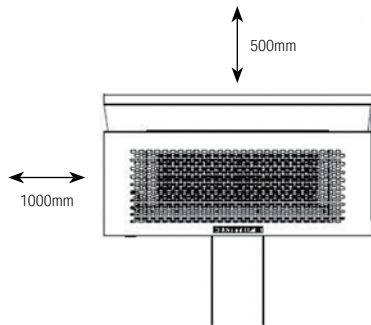

Minimum Clearances from Combustibles (top and sides)

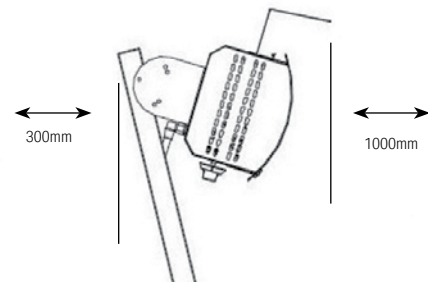

Minimum Clearances from Combustibles (front and rear)

NAT-HT14 Rev 1_09032018

FREE DELIVERY
*CONDITIONS APPLY

13 SUPA
13 78 72
supagas.com.au